

# Laser Displacement Sensors

## : Sensor head (diffuse reflective type)



## BD Series

### PRODUCT MANUAL

For your safety, read and follow the considerations written in the instruction manual, other manuals and Autonics website.

The specifications, dimensions, etc. are subject to change without notice for product improvement. Some models may be discontinued without notice.

#### Features

- Reference distance :30/65/100/300/600 mm
  - Easy maintenance with detachable sensor head/amplifier unit
  - Maximum resolution: 1 $\mu$ m (vary by model)
  - Accurate measurement with minimal influence from target color or material
  - Interconnection of up to 8 sensor amplifier units
    - : Mutual interference prevention function and auto channel sorting
  - Various calculation functions supported (addition, subtraction, average)
  - Various filter functions for stable measurement (movement average, differential, median)
  - Auto sensitivity adjustment (1-point, 2-point teaching)
  - Dedicated software provided (atDisplacement)
  - DIN rail and wall mount support (bracket accessory required for wall mount)
  - Sensor head: IP67 protection structure
- ※ Sensor head model BD-300/600 supports only over 5.0 firmware version of the amplifier unit (BD-A1).

#### Safety Considerations

- Observe all 'Safety Considerations' for safe and proper operation to avoid hazards.
- $\triangle$  symbol indicates caution due to special circumstances in which hazards may occur.

**$\triangle$  Warning** Failure to follow instructions may result in serious injury or death.

- 01. Fail-safe device must be installed when using the unit with machinery that may cause serious injury or substantial economic loss.**(e.g. nuclear power control, medical equipment, ships, vehicles, railways, aircraft, combustion apparatus, safety equipment, crime/disaster prevention devices, etc.)  
Failure to follow this instruction may result in personal injury, economic loss or fire.
- 02. Do not use the unit in the place where flammable/explosive/corrosive gas, high humidity, direct sunlight, radiant heat, vibration, impact or salinity may be present.**  
Failure to follow this instruction may result in explosion or fire.
- 03. Do not disassemble or modify the unit.**  
Failure to follow this instruction may result in fire.
- 04. Do not connect, repair, or inspect the unit while connected to a power source.**  
Failure to follow this instruction may result in fire.

**$\triangle$  Caution** Failure to follow instructions may result in injury or product damage.

- 01. Use the unit within the rated specifications.**  
Failure to follow this instruction may result in fire or product damage.
- 02. Use a dry cloth to clean the unit, and do not use water or organic solvent.**  
Failure to follow this instruction may result in fire.
- 03. Mount the ferrite core to specified position before using.**  
Failure to follow this instruction may result in output with noise.

#### Cautions during Use

- Follow instructions in 'Cautions during Use'. Otherwise, it may cause unexpected accidents.
- The power supply should be insulated and limited voltage/current or Class 2, SELV power supply device.
- Do not install where strong magnetic or electric field exist. Otherwise, the resolution may be adversely affected.
- Mutual optical interference between laser sensors and photoelectric sensors may result in malfunction.
- Mutual optical interference between laser sensors may result in malfunction.
- When connecting DC relay or other inductive load to the output, remove surge by using diode or varistor.
- Since external disturbance light (sunlight, fluorescent lighting, etc.) can cause product malfunction, use the product with a light shield or slit.
- When detecting with the maximum sensitivity, an error may occur depending on each characteristic deviation.
- This unit may be used in the following environments.
  - Indoors (in the environment condition rated in 'Specifications')
  - Altitude max. 2,000 m
  - Pollution degree 2
  - Installation category II

#### Safety precautions during Use Laser Equipment

Failure to follow this instruction may result in physical disability(e.g., eyes or skin)

- If the product is handled arbitrarily without following the instructions, it may cause laser injury.
- Do not stare at the laser emitter.
- Do not stare directly or indirectly at the laser beam or direct it to the human eye.
- Do not deliberately project laser light onto a person.
- Install the laser light path so that it does not pass at eye level.
- Consider the optical path of the laser beam.  
If there is a risk of contact with the reflected light due to mirror reflection/diffusion reflection, install a barrier to block the reflected light.

## Warning Labels

• The label description - label attachment locations for the warning labels on this device are shown below.

### Label attachment locations

BD-030 / BD-065 / BD-100

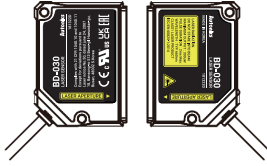

BD-300 / BD-600



### Class 1 (IEC/EN), Class I (FDA (CDRH) CFR Part 1002)

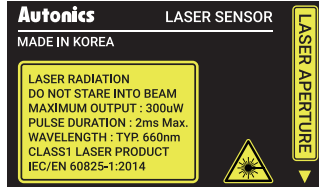

### Class 2 (IEC/EN), Class II (FDA (CDRH) CFR Part 1002)

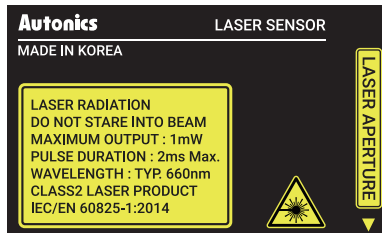

## Ordering Information

This is only for reference.  
For selecting the specific model, follow the Autonics web site.

BD - ①

### ① Reference distance

Number: Reference distance (unit: mm)

## Specifications

Model	BD-030	BD-065	BD-100	BD-300	BD-600
Beam shape	Standard				
Spot diameter (near)	≈ 290×790 μm (25 mm)	≈ 360×1,590 μm (55 mm)	≈ 480×1,870 μm (80 mm)	≈ 990×1,000 μm (160 mm)	≈ 1,140×1,175 μm (250 mm)
Spot diameter (reference)	≈ 240×660 μm (30 mm)	≈ 290×1,180 μm (65 mm)	≈ 410×1,330 μm (100 mm)	≈ 490×510 μm (300 mm)	≈ 860×830 μm (600 mm)
Spot diameter (far)	≈ 190×450 μm (35 mm)	≈ 210×830 μm (75 mm)	≈ 330×950 μm (120 mm)	≈ 365×355 μm (450 mm)	≈ 800×775 μm (1,000 mm)
Resolution <sup>01)</sup>	1 μm	2 μm	4 μm	20 μm	40 μm
Reference distance	30 mm	65 mm	100 mm	300 mm	600 mm
Max. measurement range	20 to 40 mm	50 to 80 mm	70 to 130 mm	160 to 450 mm	250 to 1,000 mm
Rated measurement ranges <sup>02)</sup>	25 to 35 mm	55 to 75 mm	80 to 120 mm	160 to 450 mm	250 to 1,000 mm
Linearity <sup>03)</sup>	± 0.1% of F.S.	± 0.1% of F.S.	± 0.15% of F.S.	± 0.25% of F.S.	± 0.25% of F.S. (250 to 600 mm) ± 0.5% of F.S. (600 to 1,000 mm)
Temperature characteristic <sup>04)</sup>	0.05% of F.S./°C	0.06% of F.S./°C		0.08% of F.S./°C	
Light source	Red semiconductor laser (wavelength: 660 nm, IEC 60825-1:2014)				
Optical method	Diffuse reflection				
Laser class	Class 1 (IEC/EN), Class I (FDA (CDRH) CFR Part 1002)		Class 2 (IEC/EN), Class II (FDA (CDRH) CFR Part 1002)		
Output	≤ 300 μW	≤ 1 mW			
Laser pulse duration	2 ms Max.				
Material	Case: PC, Cable: PVC, Sensing part: Glass			Front case: AL, Rear case: PC, Cable: PVC, Sensing part: Glass	
Approval	CE UK RoHS ENEC			CE UK RoHS	
Unit weight (packaged)	≈ 56 g (≈ 209 g)	≈ 68 g (≈ 233 g)	≈ 68 g (≈ 233 g)	≈ 151 g (≈ 330 g)	≈ 153 g (≈ 332 g)

01) When measuring white paper in stop state at the reference distance with belows.  
[Conditions] reference temperature 25°C, reference distance response time (BD-030 / 065 / 100) 1 ms, (BD-300 / 600) 2 ms, average 128 times

02) The rated measurement range guarantees linearity.

03) Measurement error for linear displacement of white matte paper in the rated measurement range.

04) Value measured by using an aluminum jig fix the sensor head and non-glossy white paper.

Supported amplifier	Amplifier unit (BD-A1) <sup>01)</sup>
Power supply	From the amplifier unit (BD-A1)
Operation indicator	Power indicator (red), Laser emission indicator (green), NEAR/FAR indicator (green)
Insulation resistance	≥ 20 MΩ (500 VDC= megger)
Noise immunity	Square shaped noise by noise simulator (pulse width: 1μs) ±500V
Dielectric strength	Between the charging part and the case: 1,000 VAC~ 50/60 Hz for 1 minute
Vibration	1.5 mm amplitude at frequency of 10 to 55Hz in each X, Y, Z direction for 2 hours
Shock	300 m/s <sup>2</sup> (≈ 30 G) in each X, Y, Z direction for 3 times
Ambient illumination	≤ 10,000 lx incandescent lamp
Ambient temperature	-10 to 50 °C, Storage: -15 to 60 °C (no freezing or condensation)
Ambient humidity	35 ~ 85%RH, Storage: 35 ~ 85%RH (no freezing or condensation)
Protection structure	IP67 (IEC Standards, except connector of extension cable)

01) Sensor head model BD-300/600 supports only over 5.0 firmware version of the amplifier unit (BD-A1)

## Product Components

- Sensor head
- Instruction manual
- Bolt ×2, Nut ×2
- Ferrite core (Manufacture: TDK, ZCAT2132-1130)
- Fixing bracket (BK-BD-□)

## Sold Separately

- Laser displacement sensor communication converter: BD-C Series
- Extension cable: [General type] CID6P-□-SI-BD, [Robot type] CIDR6P-□-SI-BD
- Fixing bracket: BK-BD-□

## Installation Step 1. Connecting Sensor Head - Amplifier Unit

- Do not supply the power when connecting / removing sensor and amplifier unit.

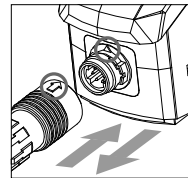

### Connecting

Insert connector of the sensor head into amplifier unit with aligning ↑ mark and ▲ mark until it sounds click.

### Removing

Pull out the connector cap of sensor head to the opposite direction.

## Installation Step 2. Selecting Sensor Head Mounting Location

The closer the distance between the sensor head and the measurement target is to the reference distance, the more accurate the measurement can be.

Select the installation location of the sensor head by checking the operation of the indicator ON and the display of displacement.

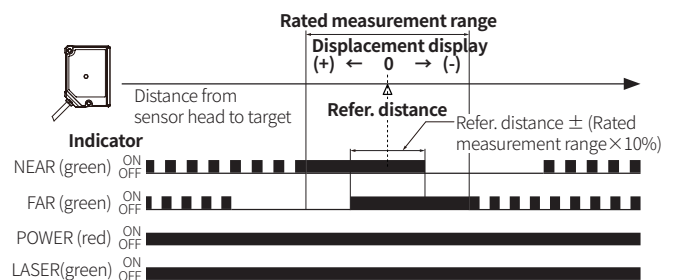

### Sensor head indicator operation

- Indicator ON operation distance (unit: mm)

Model	Reference distance	Rated measurement range	NEAR indicator	NEAR + FAR indicator	FAR indicator
BD-030	30	25 to 35	25 to 31	29 to 31	29 to 35
BD-065	65	55 to 75	55 to 67	63 to 67	63 to 75
BD-100	100	80 to 120	80 to 104	96 to 104	96 to 120
BD-300	300	160 to 450	160 to 329	271 to 329	271 to 450
BD-600	600	250 to 1000	250 to 675	525 to 675	525 to 1000

- The rated measurement range guarantees linearity specifications.

### Displacement indication

- The value is displaced more positive (+) as the object is closer to sensor head, more negative value (-) as the object is far from sensor head relative to the origin (0).

## Installation Step 3. Precautions for Mounting Sensor Head

Install the sensor head to minimize measurement error for stable measurement.

### ■ Moving object measurement

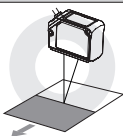
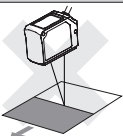
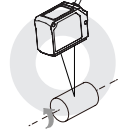
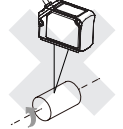
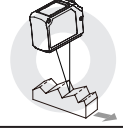
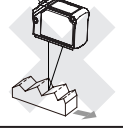
Correct	Wrong	Description
		<b>Object with material / color difference</b> Install the emitter and receiver in parallel to the material or color boundary of the object.
		<b>Rotating object</b> Install the receiver and the rotating shaft in parallel to minimize the influence of fluctuations and position deviations.
		<b>Object with step</b> Install the emitter and receiver vertically to the line between crest and valley of the object.

### ■ Narrow area or concave object

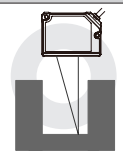
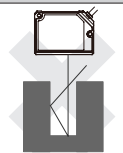
Correct	Wrong	Description
		Install the sensor head where the reflected laser beam does not get blocked toward the receiver part.

### ■ Wall mounting

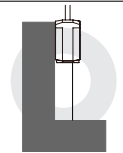
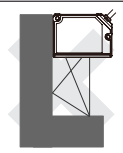
Correct	Wrong	Description
		Install the sensor head where the reflected laser beam from the wall does not enter the receiver part. If the color of wall is black with low reflectivity and no gloss, the error can be minimized.

### ■ Black object

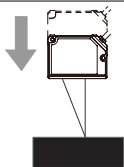
Example	Description
	When measuring black object with low reflectance the amount of light received decreases, install the sensor head closely to the object.

## Installation Step 4. Mounting

### ■ Sensor head

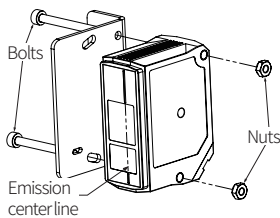

- Mount to the panel directly or through the bracket by using bolts and nuts.

Model	Bolt	Tightening torque
BD-030 / 065 / 100	M3	0.5 N m
BD-300 / 600	M4	0.6 N m

- Install the measurement object and the center line are in a straight line. Check the mounting position considering emission center line, vibration and shock.

### ■ Accessory: Ferrite core

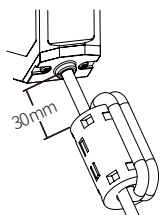

- Within 30 mm from the sensor head, wind the cable through the inside of the ferrite core three times and mount the ferrite core.

## Dimensions

- Unit: mm, For the detailed dimensions of the product, follow the Autonics web site.

A	Optical axis of emitter
---	-------------------------

### ■ BD-030

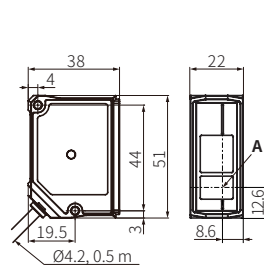

### Fixing bracket (BK-BD-A)

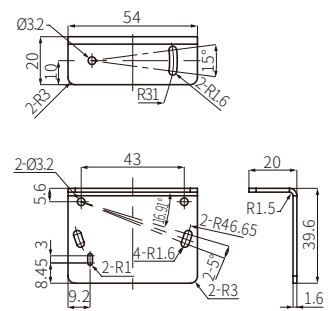

### ■ BD-065 / 100

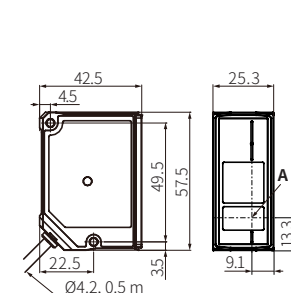

### Fixing bracket (BK-BD-B)

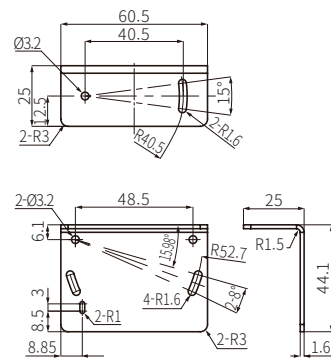

### ■ BD-300 / 600

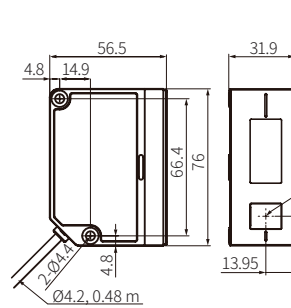

### Fixing bracket (BK-BD-D)

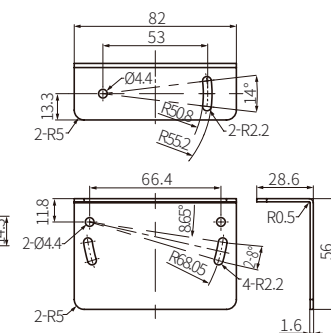

### ■ Ferrite core

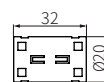

## Unit Descriptions

- It describes based on BD-030.

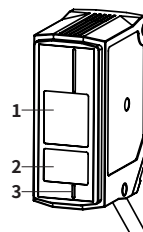

#### 1. Laser receiver

Receives the laser reflected from the measurement target.

#### 2. Laser emitter

The point at which a laser is projected on a target to measure displacement.

#### 3. Emission center line

The line and the object should be aligned because the laser is emitted along the line.

Install the measurement object and the center line are in a straight line.

#### 4. Power indicator (POWER, red)

Indicates whether the sensor head is powered or not.

#### 5. Laser emission indicator (LASER, green)

Turns ON while the laser is emitted from the sensor head.

#### 6. NEAR/FAR indicator (NEAR/FAR, green)

Flashes outside the rated measurement range and turns ON near the reference distance.

- For more information about indicators, refer to the Installation Step 2. Selecting Sensor Head Mounting Location

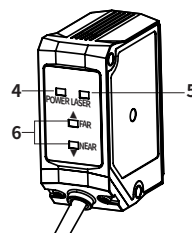

## Sold Separately: Extension Cable

• Unit: mm, For the detailed drawings, follow the Autonics website.

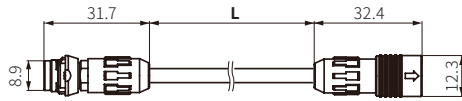

General type	Robot type	L (length)
CID6P-1-SI-BD	CIDR6P-1-SI-BD	1 m
CID6P-2-SI-BD	CIDR6P-2-SI-BD	2 m
CID6P-5-SI-BD	CIDR6P-5-SI-BD	5 m
CID6P-10-SI-BD	CIDR6P-10-SI-BD	10 m

### ■ Accessory: Ferrite core

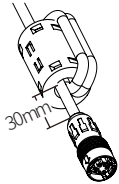

Within 30 mm from the connector of amplifier unit, wind the cable through the inside of the ferrite core three times and mount the ferrite core.

## Test for Robot Type Extension Cable

In the following each test environment, repeat the test until the sample is electrically disconnected, and then check the number of times.

### ■ Flexure test

Test environment

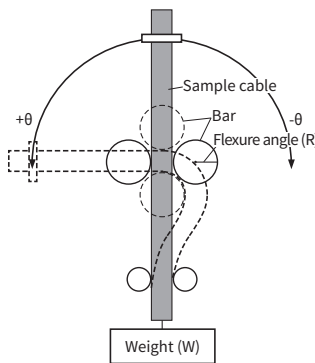

Conditions

Flexure angle ( $\theta$ )	90°
Weight (W)	1 kg
Flexure radius (R)	30 mm
Flexure speed	60 times / minute • 1 round trip is done once.

Result

≈ 32,000,000 times

### ■ Torsion test

Test environment

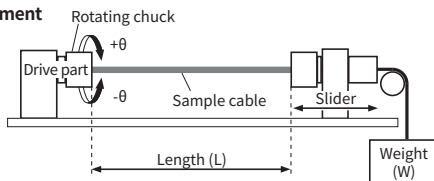

Conditions

Flexure angle ( $\theta$ )	180°
Weight (W)	1 kg
Length (L)	50 mm
Flexure speed	60 times / minute • 1 round trip is done once.

Result

≈ 30,000,000 times

### ■ U bending test

Test environment

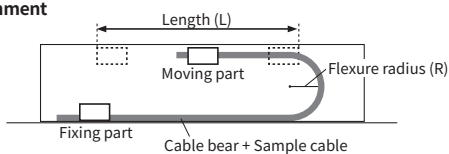

Conditions

Length (L)	400 mm
Flexure radius (R)	18 mm
Flexure speed	60 times / minute • 1 round trip is done once.

Result

≈ 42,000,000 times

## Warning Labels

• The label description (left) - label attachment locations (right) for the warning labels on this device are shown below.

### ■ BD-030

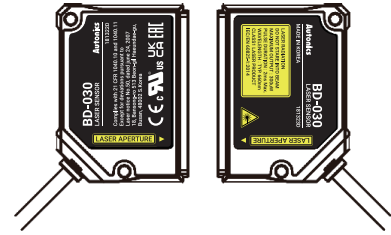
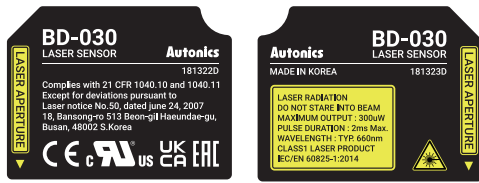

### ■ BD-065

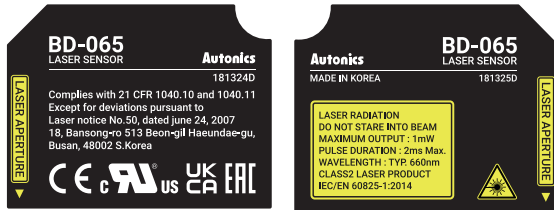

### ■ BD-100



### ■ BD-300

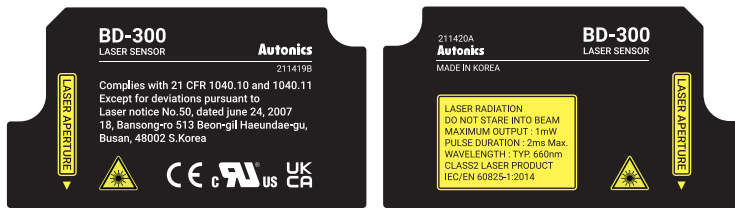

### ■ BD-600

